

Indoor Constant Current Indoor LED Driver



Features特征:

- The output current is constant.输出模式: 恒流
- Input voltage:100-260VAC.输入电压: 100-260VAC
- Using active built-in PFC techology.采用PFC技术
- Efficiency>86% PF>0.90.效率>86%功率因素PF>0.90
- Protection:SCP/OVP.短路保护 过压保护
- Fireproof PC protection.塑料防火外壳
- Lower power consumption design. 低功耗设计
- Flicker free by eyes or camera.无频闪设计
- CE/ROHS/SAA/TUV passed.CE/ROHS/SAA/TUV认证
- 5 Years warranty.5年质保

规格书Specification Sheet

名称Model	恒流源CC	MSD-CC-30W	
输出 Output	输出电压 Output Voltage	28-42V	40-60V
	恒流精度 Current Precision	±5%	
	输出电流 Output Current	700mA	500mA
	输出功率 Output Power	30W	30W
	线性调整率Line Regulation	1%	
输入 Input	输入电压 Input Voltage Range	90-130V/180-260V	
	输入电流 AC Current(Typ)	0.19A@180VAC 0.152A@230VAC 0.13A@264VAC	
	频率 Frequency Range	50-60Hz	
	功率因数 PFC(Typ)	>0.90@full load	
	效率 Full-loading Efficiency	>86%@full load	
异常保护 Protection	保护类型 Short Circuit	Short circuit protection / Over voltage protection	
	最大输入电压Over Voltage	<277VAC	
使用环境 Environment	工作温度Operation Temperature	-20~+45℃	
	工作湿度Operation Humidity	20~90%	
	存储 Storage	-20~ +85℃, 10~95%RH	
	温度系数Temperature Coefficient	±0.03%/℃(-20~50℃)	
	抗震能力Vibration Resistance	10~500HZ,2G 10Min/period,X、Y、Z line per 60 mins	
安规与电磁兼容 Safety&EMC	标准 Standard	Refer to EN-60950-1	
	耐压 Withstand Voltage	I/P-O/P:3.75KVAC	
	绝缘强度Insulating Strength	I/P-O/P:400M Ω/500 VDC/25℃/70%RH	
	传导 EMC Emission	To Correspond EN55015,EN61000-3-2(≥ 50% load)	
	辐射 EMC Immunity	To Correspomd EN55015,EX61000-4-2,3,4,5,6,8,11,A Level of light industry standard(Surge 4KV)	
其他Other	重量Weight	100g	
	尺寸Dimension	140*45*27.5mm (L*W*H)	
	PCB材质	94V-0 PC fire retardant	
	颜色Color	White	
	包装Packing	44*28*18cm/30pcs	

NOTE

All parameters are measured at normal temperture(25-28℃)
 1、Ripple & Noise are measured at 20KHz of bandwidth by using a 12" twisted pair-wire teminated with a 0.1 uf & 47uf parallel capacitor(@ full load).
 2、The efficiency measured at Max output voltage,and 230VAC with full load,if with 110VAC the efficiency will be lowered 0.5%~1.5%;Working 1~2 hours,efficiency will be higher 1.5%~1%than the initial stage.

Indoor Constant Current Indoor LED Driver

1.Mechanical Specification

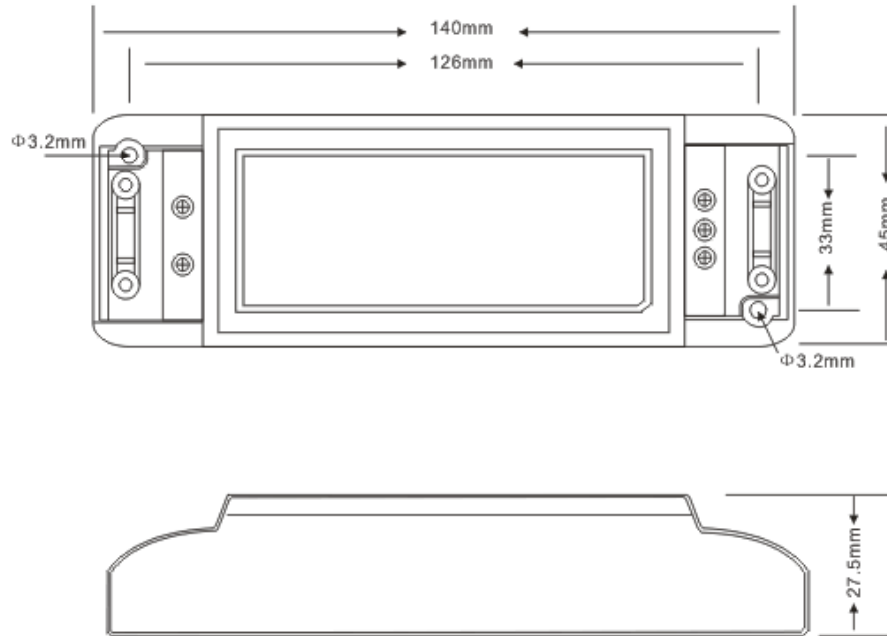

2.Power Factor & THD Characteristics

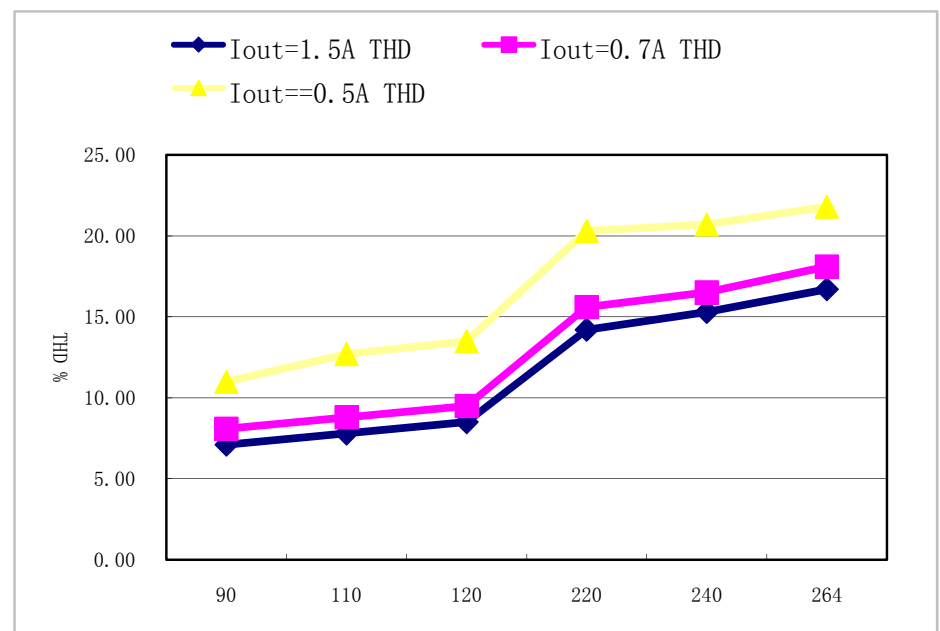
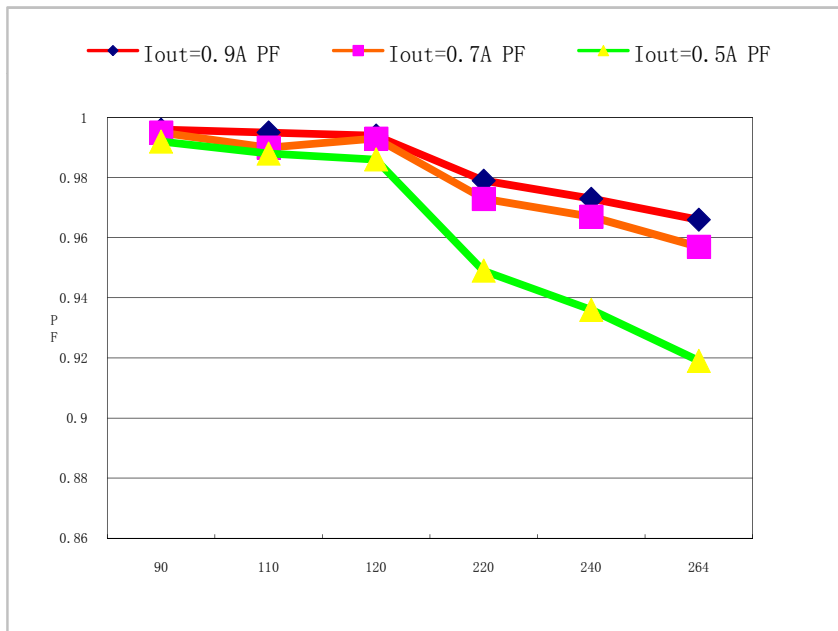

3.Efficiency & Load of (110VAC / 230VAC)

